

KOENIG & BAUER

Product Overview

00001 55444411115

we're on it.

EN



Since 1972 Koenig & Bauer Coding has been developing innovative and future-oriented technologies for industrial marking and coding; designed and manufactured to high quality standards.

We focus on first-class quality and outstanding performance at our production sites in Veitshöchheim, Germany and Linköping, Sweden.

Various technologies and different designs or configurations reliably take over the marking task in almost all industrial applications from the product to packaging and palletising. We're on it.



Performance without Compromise.

Responsible, Future-Oriented, Automated

Coding is a key part of everyday business. It affects every area of our lives, and every industry.

The more diverse, colourful, and comfortable our everyday lives become, the more variety there is among the products our customers and partners will print with our systems, now and in the future.

Today, good coding is evidence of quality for product safety and consumers. We are aware of this and take on this responsibility every day. After all, coding stands for trust.

We support our customers from project planning to implementation and beyond.

Each industry has its own requirements for the marking of its products and the technology.

To meet individual coding requirements, the Koenig & Bauer Coding portfolio provides a wide range of different technologies with suitable model variants and consumables for all applications.

Responsible use of resources and advancing digitalisation are always in our focus.

Our solutions therefore offer interfaces, predictive maintenance and cloud-based extensions for future challenges.

alphaJET

Continuous inkjet (CIJ) coding is ideal if speed and good legibility are important for applying variable data directly at the production line.

In addition to precise printing results, alphaJET printers offer you a very high degree of reliability in everyday production. Perfectly matched inks ensure the quality for your application.



	alphaJET mondo	alphaJET 5 SP / HS / HS-M	alphaJET 5 X X-FP / X
Line speed max., m/min.	780	1300 / 1300 / 800	950 / 800
Line speed max., m/min. at 2,5 mm character width	385	695 / 700 / 400	460 / 400
Max. lines	5	5 / 4 / 5	8 / 5
Max. pixel	32	32 / 24 / 32	48 / 32
Nozzle, µm	62	42 / 50 / 62	55 / 62
Active Ink Flow + cooling	-	✓	✓
Smart Start Technology	-	✓	✓
Supply hose, m	3	4 / 6	4 / 6
Ink: non-pigmented	✓	✓	✓
Ink: pigmented	-	✓	✓
RE-SOLVE Ultra*	✓	✓	✓
Touch display	8,4"	10,4"	10,4"
Managed Services	✓	✓	✓
Special software (e.g. Nicelabel)	-	✓	✓
Ethernet, RS232, USB-Port, I/O-Interface, programable alarm relay	✓	✓	✓
Protection class IP 54	✓	✓	✓
Dimensions (H x W x L; mm)			
Housing	455 x 350 x 290; 18 kg	592 x 320 x 320; 23 kg	620 x 321 x 320; 23 kg
Print head	145 x 40 x 40; 2 kg	190 x 47 x 40; 2 kg	190 x 47 x 40; 2 kg

Benefit from the savings potential of the alphaJET with the efficient RE-SOLVE Ultra solvent recovery. Lowest consumption in combination with affordable costs for consumables saves you money every day.

Explore the special features of the alphaJET 5 for yourself with the interactive animation on our website: <https://coding.koenig-bauer.com/en/special-pages/showroom/alphajet5-x/>



Key advantages alphaJET

- Best TCO values (Total Cost of Ownership) through to favourable prices for consumables, low solvent consumption and low-maintenance operation.
- Significant savings potential due to the modular design of the components, which are extremely easy to clean, remove or replace.
- High availability thanks to the use of high-quality components and efficient cooling of the ink system even at higher ambient temperatures.
- Extremely long life cycle of the pump motors, that has been independently confirmed.
- Ink portfolio for almost every application: pigmented, hard pigmented and non-pigmented, high-contrast & sustainable, with best adhesion properties and many more.
- Highest print speeds and lowest emission values.



More information:

<https://coding.koenig-bauer.com/en/products/continuous-inkjet-systems/>

Print samples alphaJET

m7x5

ABCDEFG 1234567890
ABCDEFG 1234567890
ABCDEFG 1234567890

ABCDEFG 1234567890
ABCDEFG 1234567890
ABCDEFG 1234567890

ABCDEFG 1234567890
ABCDEFG 1234567890
ABCDEFG 1234567890

m5x5

ABCDEFG 1234567890
ABCDEFG 1234567890
ABCDEFG 1234567890

OCR 11x7

ABCDEFG 1234567890

ABCDEFG 1234567890
ABCDEFG 1234567890

Nozzle

ABC 123

62 µm

ABC 123

55 µm

ABC 123

50 µm

ABC 123

42 µm

Codes



123456

Code 39



8 712100 735141

EAN 13



DMC



QR-code



DOT code

Logo, language, colours

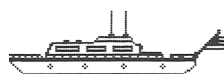

小字符喷码机 alphaJET 系列

The combination of optimised nozzle shutter, nozzle flushing and head heating creates the Smart Start Technology integrated in the alphaJET 5 for perfect start-stop behaviour. Even if the printer is in stand-by mode for a longer period of time, there is no need for an intermediate start-up or extended cleaning processes before restarting the production line. This saves valuable time.

Print head

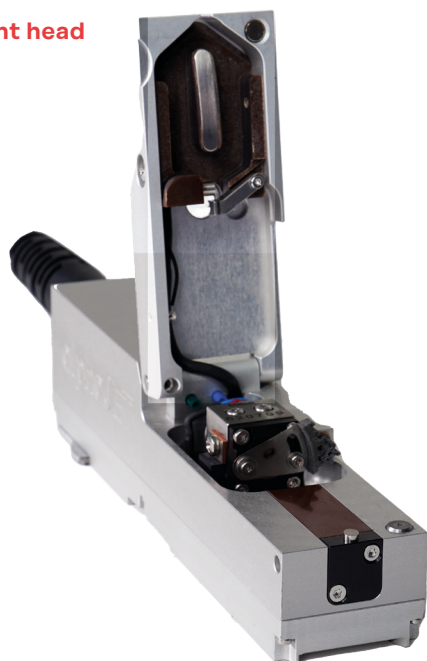

- **Smart-Start-Technology**
 - motorised nozzle shutter
 - automatic rinsing of the nozzle prevents from drying
 - minimises the cleaning effort
- **Active Ink Flow** ensures optimum ink viscosity. The result is a consistent superior print quality.
- The **compact design** allows integration even when space is limited.
- Thanks to the **modular design**, individual parts are very easy to clean or to exchange.

Laser

Laser coding is ideal for permanent marking that is absolutely smudge-proof and abrasion resistant during the production process. Lasers are versatile, low-maintenance, and absolutely reliable in automated environments.

Coding lasers offer not only precise markings for product identification and decoration, but also excellent reliability and cost savings in your everyday production. The Koenig & Bauer Coding portfolio offers models to meet your needs in every application to fulfil individual printing requirements.



	Entry	Advanced			High-End	
	SPARK	SPA2 C	SPA2 FP / FF	SPA2 DN	SPA2 D	SPA2 D UV
Technology	CO ₂	CO ₂	Fibre	YAG	YAG	UV
Performance W	10 / 30	10 / 30 / 80	20 / 50 / 100	6 / 20	6 / 10 / 20	5 / 15
Beam path	90°	90° / 0°	90°	90°	90° / 0°	90° / 0°
Option:						
- Marca Full Graphic	✓	✓	✓	✓	✓	✓
- Profinet	✓	✓	✓	✓	✓	✓
- Touch screen	✓	✓	✓	✓	✓	✓
- Pilotlaser		✓	✓	✓	✓	✓
Speed * m/min.	250	250	660	250	250	250

*max. 1-line, average coding speed under optimum conditions

Supplement your laser with practical **accessories** such as an extraction unit, hand-held scanner, sensors and camera, and with a **software solution** that supports you. You are already using the label software NiceLabel? If so, you can continue to create your print label with NiceLabel, because our lasers also support this printer driver.

The material and laser technology used determine the how laser coding functions.

When the targeted laser beam hits the material, it creates a reaction called laser coding or laser marking. This reaction differs depending on the material used.

- Targeted **removal of colour**, typically from printed or coated materials.
- **Colour change**: material or admixed pigments react in a controlled manner to the beam, e.g. light to dark or dark to light.
- **Engraving**: laser removes material from the workpiece. This can be seen and felt.
- If a steel surface is heated in a localised area with a laser beam, the **annealing colour** results after cooling.
- During **foaming**, plastic is melted in a defined way by the laser beam.
- **Cutting / scoring / perforating** with precision, e.g. for vouchers and sachets, diffusion perforation of plastic film.

Key advantages Laser

- Lasers are low maintenance and require no consumables - this saves time and money and protects the environment.
- Ultra-High-Speed (UHS) print heads enable sophisticated marking even at the highest speeds.
- Open interfaces facilitate customer-specific connectivity.
- Compact design and selectable beam path enable integration even in limited spaces.



More information:

<https://coding.koenig-bauer.com/en/products/laser-systems/>

Print samples Laser

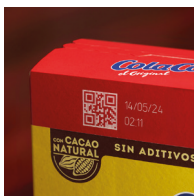

food



beverages



household



cosmetics



pharmaceuticals



foil / films



glass



paper



plastic



wood / cork



automotive

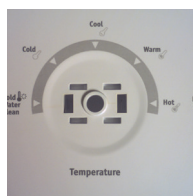

electronic



cable



components

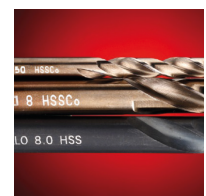

tools



metal



pipe



fruit / veg

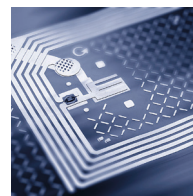

board



additive / silicones

Product coding must be adaptable to the requirements of your production line. We support you with standardised and individually planned application solutions. Whether a stand with a safety enclosure, a marking station with a conveyor belt or a freely planned application.

4PL

Print & Apply technology is ideal for printing variable data and information directly and accurately applying it individually with respect to shape, colour and material onto a variety of products and packaging with pinpoint precision.

4PL labelling solutions rely on the tried-and-test Zebra technology and can be modularly configured with different applicators.

4PL Print & Apply with modular applicators is designed for modern production and high quality standards. From a stand-alone solution to implementation into databases and ERP systems, the 4PL labelling solution offers you the opportunity for stepless integration. Even ready-made modules for monitoring by scanner or camera can be found in our modular system. There is nothing to prevent you from starting with automation.

4PL-Applicator

Cobot	collaborative robot arm, certified according to ISO 13849-1, repeatability +/- 1mm
Tamp/ E-Tamp	left / right with stroke up to 200 mm or 400 mm, vacuum / fan pad
Rotary	left / right
Swipe	left / right for labels up to 180 mm high
Pallet	pneumatically controlled applicator with corner stand



4PL in Action

<https://youtu.be/--d7l08I0-g>

4PL-Print options	Zebra ZE521 6"	Zebra ZE511 4"
Print resolution, dpi	300	300
Label width, mm	76 - 180	16 - 114
Print width max., mm	168	104
Print speed max., mm/s	305	305
Design	right / left	right / left
Touch display PC	option	
Electrical power	115 - 230 V / 50 - 60 Hz / 110 VA	
Air supply (Tamp)	6 bar, compressed air clean and dry	

The **thermal transfer printer** generates print images for label design from all common software on request.

In addition, you receive a free Windows printer driver. With this, content can be transferred to the printer from all Windows programmes. This makes it easy to convert existing print images.

When developing the 4PL product range, we focused on **high-quality components** from international market leaders. The print image automation is therefore realised by NiceLabel.

Adding a **touch screen** makes the 4PL a stand-alone device. With a user interface tailored to your application, operation becomes simple and intuitive.

Do you want to be sure that the correct barcode has been printed? Then we will implement a **barcode scanner** on the applicator for you. This will check the labelled product directly afterwards.



Key advantages 4PL

- Attractive price-performance ratio with best quality.
- Highest flexibility through easy exchange of modular components.
- Expertise over many years supports from stand-alone solutions to label management and complete process automation.
- No protective fence required under the machinery directive.
- Maximum availability and simple operation.
- Minimised service effort optimises costs.
- Process-safe and gentle labelling of sensitive goods thanks to automatic product detection.



More Information:

<https://coding.koenig-bauer.com/en/products/print-and-apply/>



4PL Swipe labels the product in a linear movement. A brush or roller additionally presses the label onto the product and thus also enables labelling on curves or slight slopes.

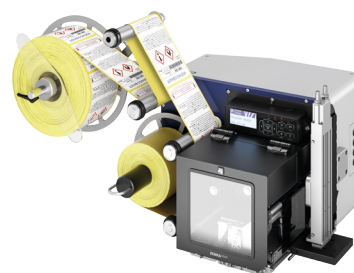

4PL Tamp / E-Tamp labels your product from one side while stationary or in motion. The all-electric E-Tamp does not require any compressed air at all.



4PL Rotary for labelling from two sides in one step or around corners. Alternatively, the coding can be done from the front and then directly from the side. With two 4PL Rotary devices a wrap-around labelling can be achieved.

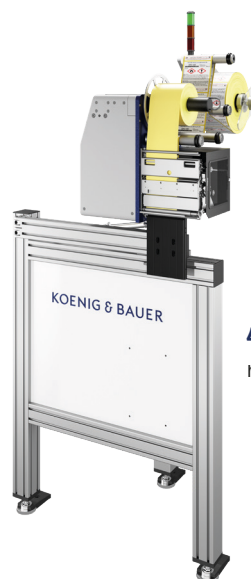

4PL Pallet can label pallets reliably and safely.

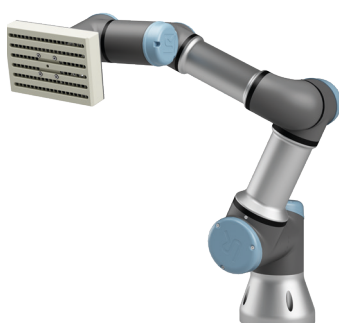

4PL with Cobot applicator uses the cobot arm which can be taught-in at the touch of a button, to apply labels to any areas of your product, even hard-to-reach areas (e.g. the inside of a crate).

Does the position of the labelling vary?

We can integrate a fitting scanner.

You need the 4PL Cobot for different tasks or products?

Taught-in processes can be saved and easily reproduced.

DOD-Inkjet Printer (Drop-on-demand)

betaJET

Marking with DOD inkjet printers is the perfect solution when high-resolution results and future-proof technology, including GS1 compatibility, are very important for applying variable data directly on the production line.

The betaJET DOD-inkjet printer range is ideal for marking primary and secondary packaging made of different materials, with absorbent, porous and with non-absorbent surfaces.



betaJET	TJXe	MRX72e	HRX GS05	HRX GS10
	Thermal-DOD	Piezo-DOD	Piezo-DOD	Piezo-DOD
Printing height, mm	12,7	< 72 mm (2,8")	< 72 mm (2,8")	< 72 mm (2,8")
Printing speed, m/min	120	< 110	< 250	< 250
Printing frequency, prints/s		4	< 30	< 30
Printing resolution vertical, dpi	300 - 600	180	90 - 180	90 - 360
Printing resolution horizontal, dpi	300 - 900	180 - 720	1440	1440
Printing length, m		8	8	8
Position print head	side, top	side, top, inclined (0°- 90°)	side, top, inclined (0°- 90°)	side, top, inclined (0°- 90°)
HMI/Touch display	1,7"	7" / 10" HMI	7" / 10" HMI	7" / 10" HMI
Options				
UV-LED	✓	✓	✓	✓
external beacon	-	✓	✓	✓
Features				
Grayscale	-	-	3	7
CPE "Contrast per Element"	-	-	✓	✓
FI System "Flex Integration"	-	-	✓	✓
automatic bottle detection	-	✓	✓	✓

betaJET TJXe Thermal-DOD Inkjet

Easy operation and self-configuring 40 ml ink cartridges. This reduces operating errors. The compactness of the TJXe system enables integration even in the smallest of spaces. Water-based (absorbent), solvent-based (coated) and UV LED curing inks are available as standard.

betaJET Piezo-DOD Inkjet

You can print static and variable texts, logos, codes and much more in the highest print quality and with high resolution using binary piezo DOD inkjet printers. Choose mineral oil-free ink for absorbent materials or low-migration UV ink with compatible UV LED curing for marking smooth surfaces.

1 to 2 print heads are controlled intuitively with the 7" HMI; the alternative 10" HMI controls up to 4 print heads.

betaJET MRX72e

High-resolution piezo DOD inkjet printer, for (almost) any of application.

betaJET HRX,

High-resolution piezo DOD inkjet printer that allows prints in grayscale and contrast adjustment for each print element in the same print image is possible. The HRX models GS05 are available for 3 grayscales and GS10 for 7 grayscales.



Key advantages betaJET

- Low ink price and solvent-free printing saves costs.
- Sustainable: almost emission-free, mineral oil-free ink, low waste and low consumption.
- Self-explanatory and extremely low maintenance technology.
- UV ink for coated and non-absorbent surfaces enhances the range of applications.
- Easy integration thanks to standard brackets and interfaces.
- Automatic bottle detection secures the printing process.
- Simple print image creation with Nicelabel, UBS Designer, Codesoft, ZPL emulator
- Future-proof marking, e.g. GS1 and SmartID barcode, EPAL certified.



More Information:

<https://coding.koenig-bauer.com/en/products/dod-inkjet-systems/>

Print samples betaJET



corrugated cardboard



unpainted cardboard



varnished cardboard



wood

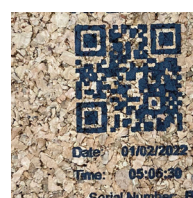

cork



styrofoam

Grayscale

The unique printing in intensity grades, *Grayscale*, takes marking with DOD Inkjet to a new level. Detailed, defined printing in monochrome color gradation graphically depicts the print image in intensity and expression. This technology leaves nothing to be desired, even for demanding print images.

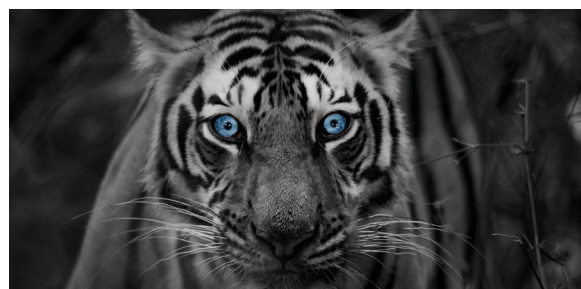

Tuning - CPE (Contrast per Element)

This technology enables different contrast values in the same print image, i.e. the contrast can be set individually for each element (text, barcode, logo, etc.). This increases the potential for ink savings by, for example lower contrast for text elements and higher contrast for barcode elements in one print image.



UVLED 7225 the integrated solution

UVLED ink for all non-absorbent surfaces, e.g. glass, plastic, coated material, paper, cardboard, wood, metal, etc.

The fast curing of the ink with UVLED offers even more design flexibility for product coding, e.g. cosmetics, pharmaceuticals, electronics, automotive and is particularly suitable for the most demanding production lines.



**Koenig & Bauer stands for tradition and innovation,
for high-quality products and reliable partnership.**

The solutions we provide enable our customers and partners to realise their visions and goals. We combine labelling technology and applications so that the greatest possible variety of product identification can make our lives easier, safer, more reliable and more convenient.

Coding and labelling is our speciality and we will not give up until we have found the best solution. We are the coding experts with the longest tradition and experience. We have been there when it matters - for over 50 years and will continue to be in the future. True to our Koenig & Bauer claim: "we're on it."

No matter what new challenges our customers face, we are already in the process of developing a solution. No matter what social or economic developments come our way, we are ready to embrace them and prepare the company for the future in the best possible way.

alphaJET



ttPRINT



udaFORMAXX



betaJET



laserSYSTEM

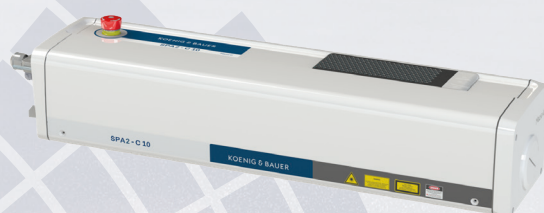

4PL

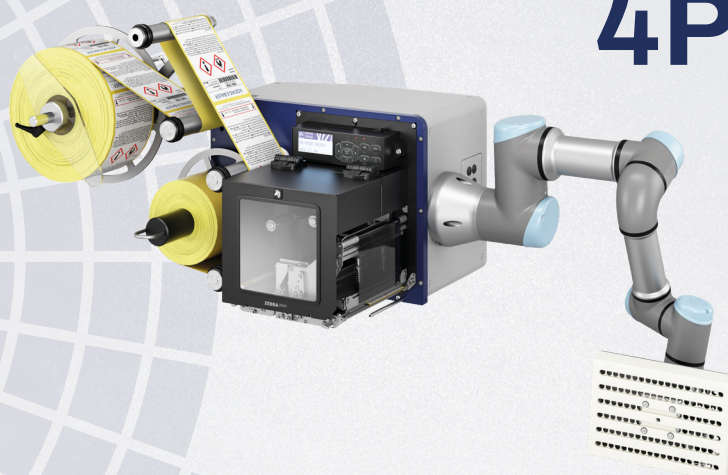

hpdSYSTEM



Hot foil coding

hpdSYSTEM

For first-class printing results in product coding, the hot foil coding process has been a trusted system for years offering good economic efficiency and operating security.

hpdSYSTEM printers offer both brilliant print results and unbeatable robustness and service life. Typical areas of application for hot stamping are food and confectionery, film packaging, cosmetics, pharmaceuticals and drugstore articles, cables and pipes, electrical, components and tyres.



hpdSYSTEM	nano	vario	magno	moto	TR
Print surface max. mm	15 x 30	30 x 50	50 x 80	20 x 20	15 x 15
Speed max., prints/min.	500	1000	60	60	5
Print time, ms	50 - 2000	20 - 2000	70 - 2000	20 - 2000	20 - 2000
Temperature, °C	50 - 200	50 - 220	50 - 200	50 - 220	50 - 180
Print pressure at 6 bar, N	373	580	1070	580	750
Foil length, m	122	305	305	305	183
Foil diameter (max.), mm	72	100	110	100	85
Foil feed, mm infinitely adjustable	2 - 15	2 - 30	2 - 50	automatisch	30
Sequence control	-	✓	✓	✓	✓
Core scanning	-	✓	✓	✓	✓
Mains voltage	24 V DC / 90 VA	24 V DC / 130 VA	24 V DC / 170 VA	24 V DC / 130 VA	24 V DC / 130 VA
Compressed air, Ø 6 mm, bar	4 - 6	2 - 6	3 - 6	2 - 6	2 - 6
Variations of hpdSYSTEM	vertical or horizontal, right or left				
Dimensions (H x W x L), mm	V: 270 x 88 x 129 H: 142 x 235 x 127 8 kg	V: 206 x 190 x 166 H: 142 x 285 x 166 10.5 kg	201,5 x 291 x 169 8,6 kg	146 x 293 x 176 8 kg	210 x 305 x 180 10.5 kg

Functioning: A heated cliché transfers the pigments of an ink foil/ribbon to the product.

hpdSYSTEM nano

Miniature hot foil device with small dimensions for the use in packaging machines offering limited space.

hpdSYSTEM vario

The hot foil cassette device stands out with quick cycle times and easy handling using a foil cassette. The cassette is very easy to fit with coloured foil outside of the printing mechanism. For even quicker foil exchanges, simply add an exchange cassette to the printer.

hpdSYSTEM magno

Hot foil printing mechanism with side button. The unique feature of this system is an extremely large print surface stretching to the edge of the product.

hpdSYSTEM moto / hpdSYSTEM TR

Special devices with patented swivel type or rotating print head for up to 8 different characters, specially developed for the tire industry.

Key advantages hpdSYSTEM

- The most economical technology for marking and coding:
 - highest uptime
 - robust and long lifetime
 - low investment in equipment and operating resources
- Infinitely variable film feed reduces film consumption.
- Simple operation and clean handling.
- Brilliant colour variety, special colours in RAL and Pantone on request.
- Suitable for sensitive environments, as absolutely harmless and emission-free.



More Information:

<https://coding.koenig-bauer.com/en/products/hot-foil-systems/>

Print samples hpdSYSTEM

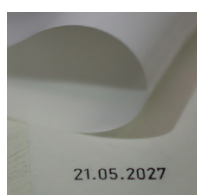

film



cable



plastics



blind embossing



labels



tires

Exchange cassettes for hpdSYSTEM vario/moto/TR

- for quick foil exchanges
- offer true flexibility for a wide variety of foil colours
 - including specialised colours
- simplify handling
- shorten your set-up times

For manual coding tasks – such as for tires, tubes, cables, etc. – we offer standardised manual **workstations** with the right hpdSYSTEM printer.

Standardised device brackets for optimal integration

- custom height adjustment
- simple lateral adjustment using a turning spindle
- hpdSYSTEM printer turns in 90° steps with locking feature
- various widths up to 1,000 mm available in the standard version
- special sizes available

Print types und galleys

We produce magnesium or silicone embossing plates in our in-house engraving manufacture as well as steel or brass print type according to your specifications: Custom Fonts, logos, or drawings – quickly, reliably, and guaranteed.

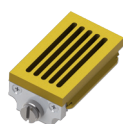

longitudinal grooves

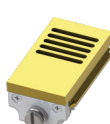

transverse grooves



with numbering machine

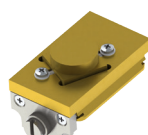

with patented swivel type

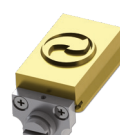

custom galley



type



concave type

Thermal transfer (TT)

ttPRINT

Thermal transfer printers (TT) are ideal for high-resolution print quality on flexible packaging materials such as tubular bags, tray seals, films, folding boxes and labels.

ttPRINT printers are designed for installation in labelling and packaging machines in any application, including moulding or thermoforming machines very well suited for both cycled and continuous production. The branch-independent versatility is shown in the printing of variable data, e.g. best-before date, individual batch numbers, special promotions up to large-format ingredient lists in excellent print quality.

Marking with thermal transfer combines all requirements for security, operability, design and best performance for any application. You get brilliant print results and a very high degree of flexibility.



ttPRINT 53 / 107 / 128

ttPRINT XS

TT-ML 53 / 107 / 128

Intermittent printing

Print surface (L x W), mm	53,3 x 75	106,6 x 75	128 x 75	53,3 x 40	53,3 / 106,6 / 128 x bis zu 630
Print speed mm/s	50 - 600	50 - 600	50 - 600	50 - 400	50 - 500

Continuous printing

Print surface (L x W), mm	53,3 x 6000	106,6 x 3000	128 x 3000	53,3 x 3000	
Print speed mm/s	50 - 800	50 - 600	50 - 450	50 - 400	
Foil/Ribbon length, m	900	600	450	600	600
Dimensions (H x W x L), mm					
Printing device	204 x 182 x 235, 9,5 kg	204 x 182 x 290, 11 kg	204 x 182 x 310, 11,7 kg	190 x 180 x 208, 6 kg	188 x 370 - 860 x 265/320/340, 9 - 16 kg
Control unit		251 x 207 x 97, 5,5 kg		242 x 117 x 220, 3,8 kg	127 x 287 x 250, 4,5 kg

for all TT

Foil design (coloured side)	Ink out / Ink in
Device variations	right / left
Compressed air, Ø 8 mm, bar	3 - 5
Protective class	IP 20

Functioning: The dots of a thermal bar are - according to the print image - electrically controlled, heated and release pigments from a dye ribbon, which are transferred to the product and result in the print image.

TT-ML with the "multi-web" printing function is ideal for variable coding of multiple small products or for applications with large-surface printing (such as lists of ingredients).

Key advantages ttPRINT

- Brilliant, detailed print image with the highest degree of flexibility in print image design – even in large formats.
- Standardised mounting frames for all common packaging and labelling machines.
- Quick foil exchanges with exchange cassettes saves time.
- Suitable interfaces for integration and monitoring over the in-house network: Ethernet, RS232, USB port.
- Integrated automatic film-saving function on all devices increases production throughput, reduces set-up time and consumables costs.





More information:

<https://coding.koenig-bauer.com/en/products/thermal-transfer-systems/>

Print samples thermal transfer (300 dpi)

use-by date, batch number, plain text

	11.11.2020	
	11.11.2040	EXP: 01.01.2031 LOT: S2 3911 11:52
	1234567890	

1D- und 2D-Codes

	GTIN: 07046261398572 Batch: Koenig & Bauer EXP: 130331 S/N: 19067811811
---	--





QR-Code



Koenig & Bauer Coding GmbH
coding.koenig-bauer.com
T: +49 931 9085 0
F: +49 931 9085 100
info-coding@koenig-bauer.com

colour variety

[LOGO]	1234567890	
[LOGO]	1234567890	
[LOGO]	1234567890	

lists of ingredients



Exchange cassettes for ttPRINT 53/107/128

- for quick foil exchanges
- offer true flexibility for a wide variety of foil colours – including specialised colours
- simplify handling
- shorten your set-up times

Standardised mounting frames

for simple integration into current packaging and labelling machines, a wide variety of widths up to 1,000 mm are available in the standard version. We can also manufacture customerspecific mounting frames upon request.

Software

- suitable for control e.g. Software NiceLabel
- configuration software ConfigTool
- Windows printer drivers (WIN7, WIN8, Win 8.1, WIN 10)
- Zebra simulation program (ZPL).

Optimal protection against dust and splash water for ttPRINT 53, 107 and 128. Simply exchange the colour ribbon cassette for a **cleaning cassette** to clean the device with water jets. The exchange can be completed in a seconds. The electronics are protected with a separately secured controller.

udaFORMAXX

Offline coding is ideal for applying variable data flexibly and precisely in small and medium batch sizes outside the production line. Even with small print runs, individual information or dedications can be set up in no time at all. A solution that has been proven many times over and internationally for the production of fresh, promotional, seasonal and special products.

The udaFORMAXX for flat folding boxes, blisters, sleeves and cardboard blanks can be equipped with different marking and coding systems.



	udaFORMAXX i	udaFORMAXX c	udaFORMAXX c XL
Operatingmode	continuous / intermittent	continuous	continuous
Output max., pc./min.	750	750	750
Transport speed, m/min.	9 - 90	9 - 90	9 - 90
Sound level, dB	66	66	66
Controller with graphic display	Standard	Standard	Standard
Weight, kg	114	114	130
Dimensions L x W x H, mm	1300 x 710 x 520	1300 x 710 x 520	1855 x 710 x 560
Integration area for coding/inspection devices, mm	560	560	1115
Printing material			
Dimensions min. (optional) W x L, mm	30 x 60	45 x 64 (32 x 45)	45 x 64 (32 x 45)
Dimensions max. (optional) W x L, mm	450 x 500	372 x 430 (372 x 500)	372 x 430 (372 x 500)
Material thickness min., g/m ²	100	100	100
Material thickness max., mm	7,5	5,0	5,0

Accessories for process optimisation

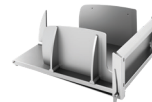

	Reject station i / c	Outfeed tray	Shingling conveyor
Operatingmode	continuous	continuous / intermittent	continuous / intermittent
Output max., pc./min.	250	750	750
Transport speed, m/min.	9 - 54	9 - 90	9 - 90
Dimensions L x W x H, mm	875 x 580 x 315	625 x 482 x 260	1207 x 527 x 333
Weight, kg	41,5	10,5	38
Sound level, dB	76 (rejection)	-	66

The integration of the modular rejection unit automatically separates faulty products into a separate container and supports quality assurance through flawless production.

Stacking the marked folding boxes or blanks neatly at the end of offline coding makes it easier for the machine operator to remove them.

A shingling conveyor as an alternative to the stacker. The shuffle board offers larger reception capacity in continuous operation and makes product removal easier.

Key advantages udaFORMAXX

- An economical offline coding solution that can be adapted to the task at hand quickly and flexibly.
- Greatest possible flexibility thanks to an enormous variety of materials and formats.
- Highest availability and simplest operation reduce operating faults and provide production reliability.
- Minimal service effort optimises costs. Future-proof with numerous modular configuration options.



More Information:
<https://coding.koenig-bauer.com/de/produkte/offline-loesungen/>

Samples for Offline Coding



flat folding boxes,
incl. automatic folding bottom



cardboard blanks, single sheets,
paper blanks, envelopes, blisters, etc.



other packaging shapes
e.g. flat and block bottom bags

The udaFORMAXX has several connections as standard, so that you can select both label applicators and **marking and coding systems** e.g.

- alphaJET continuous inkjet printer
- betaJET DOD inkjet printer
- Laser
- 4PL Print & Apply
- hpdSYSTEM
- ttPRINT



udaFORMAXX in Action
<https://youtu.be/adgYjV6IXAU>

Separate your packs precisely and at speeds of up to 90 m/min, i.e. up to 750 pc./min.

Optional double detect sensing ensures that every single product is processed correctly.

By connecting scanners and camera systems, you can monitor offline production and ensure the right print on the right packaging.

Control the udaFORMAXX including the printing and coding systems via an external PC system or parameterise the entire system directly via the internal operating display.

Using a hand scanner makes setting up individual jobs directly in the production environment simple and reliable.

For special formats and designs, our in-house engineering expertise will help you find the optimal solution.

Tailor-made services

Good coding is a quality feature for production reliability - from logistics to the end consumer. It is important to maintain this at a consistently high level. We support you and your team with our customised services.

- Safeguarding your production by minimising operator errors and reacting quickly on your own.
- Maintaining excellent print quality through optimal operation on and in the system.
- Reduction of downtimes and the associated costs.



Training

Operation, service and maintenance.

Especially in a running production, a quick reaction is required in case of emergency. Well-trained employees know the tricks and tips!

We pass on our know-how in-house, at your site or in an online training course:

- correct handling
- self-reliant maintenance
- independent troubleshooting



Service and maintenance

You dedicate yourself to your core business, we ensure the availability of your coding device.

An unexpected production stoppage always has negative consequences. In addition to the sudden loss of production, there is also the stress on the line. By choosing our service plans, we will automatically remind you when maintenance is due. Regular servicing

- keeps your print image perfect
- maximises the life of your coding and marking system
- minimises the cost of unscheduled service calls

In brief: you can prevent printer breakdowns, avoid repairs and save money.



Project planning and customised application

From analysis to implementation.

Our competent engineers support you with comprehensive and long-standing expertise - also in special machine construction. Individual integration into your existing production lines is handled by our applications department with direct access to our in-house CNC machinery.

Your advantages are obvious:

- full-range supplier for industrial coding and marking
- contact partner for your individual project
- comprehensive partner network



Consumables and spare parts

Standardised or individual.

The large portfolio of consumables for all technologies, including new in-house developments, and the close technical coordination between our development departments for equipment and consumables, leads to continuous use in production:

- optimum running properties
- broad and constantly growing portfolio, tailor-made to customer requirements
- high quality and reduced consumption



Framework contracts and call-off orders

Clever purchasing strategies save time and money.

By concluding blanket and call-off orders, you show supply bottlenecks and price fluctuations the red card. Benefit from:

- short delivery routes
- stable and plannable conditions
- outsourced warehousing



Rental concepts

An attractive alternative to buying. The principle: rights of use instead of ownership.

Reduce the capital investment for your assets. You can rent our marking and coding devices very easily and cost-effectively. This does not tie up your capital and does not require depreciation.

- You invest and yet remain liquid.
- You are flexibly moving with the times and always use modern, high-performance equipment.
- You set the rate individually to your requirements with transparent costs.

EXCEEDING PRINT

Digital

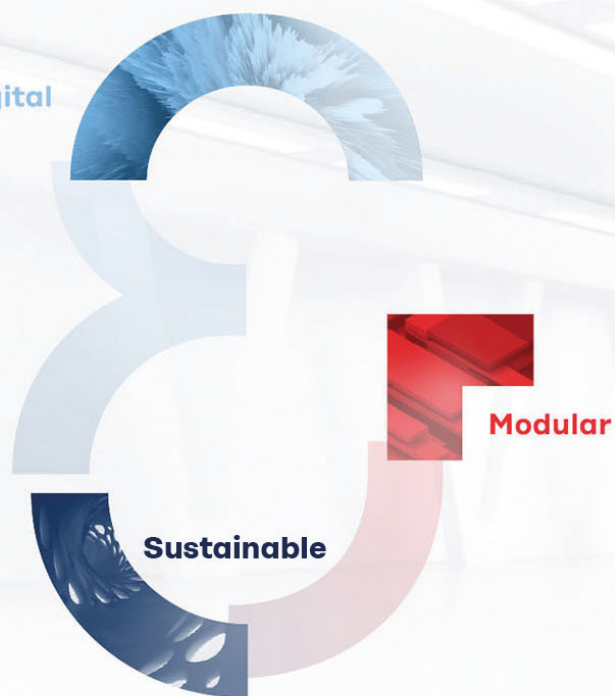

Exceeding Print

Sustainable - Digital - Modular

With its “Exceeding Print” strategy Koenig & Bauer is driving sustainability as the packaging industry's biggest challenge for the future and continuing its leadership in digitalisation.

In addition to our responsibility to our customers and employees, as a member of the world's largest sustainability initiative, the UN Global Compact, we want to do even more justice to our ecological, social and societal responsibility.

We are becoming more sustainable

The future still has so much to offer and so much to discover. By supporting numerous initiatives and projects, as well as a roadmap for complete CO₂ neutrality in our production plants from 2030, we are meeting what is probably the greatest challenge of our time. We are pushing sustainability targets in reducing the environmental footprint of us all:

- Accelerating the portfolio of solutions for a circular economy through products, substrates and process know-how.
- Create innovations to replace non-ecological packaging and reduce waste.
- Enabling customers to work in an energy- and resource-efficient way to work.

We are becoming more digital

Networking machines, collecting and analysing data and controlling processes efficiently: There are many sides to the digital transformation of the printing industry. Koenig & Bauer provides well thought-out innovations and customer centric solutions that go beyond pure printing.

- Transparent, data-supported processes are the starting point for greater efficiency and profitability.
- Risks can be minimised through a high degree of automation and the entire printing process can be designed individually and with the future in mind.
- With pioneering digital solutions and new business models, we are paving the way to a successful and sustainable future for our customers.

We are becoming more modular

Individual requirements are increasingly determining everyday life. We are meeting this challenge with modular and standardised systems. Modularisation and standardisation lead to

- Benefits of flexibility and efficiency which results in cost-saving potential.
- A high degree of standardisation. The number of "common parts" used across the entire range is increased at various levels. This simplifies spare parts availability and inventory.
- Possibilities for process optimisation in product development and design as well as in assembly.

**Exceeding Print
because there is still so much to discover.**

Koenig&Bauer Coding GmbH
Benzstraße 11
97209 Veitshöchheim, Germany

T +49 931 9085-0
F +49 931 9085-100
info-coding@koenig-bauer.com

coding.koenig-bauer.com

Contact

Your non-committal inquiry by email or by telephone is the first step. Please contact us.



Analysis

Our experts will work with you to clarify your current situation and identify your demands.



Concept

According to your demands we will make you an attractive offer and, if you wish, carry out a test run in your production.



Result

If you agree with that concept, we will realise your order and support you throughout the entire implementation process.

Text excerpts and illustrations may only be used with the permission of Koenig & Bauer Coding GmbH. Illustrations may show special equipment which is not included in the basic price of the systems. The manufacturer reserves the right to make technical and design changes.

